

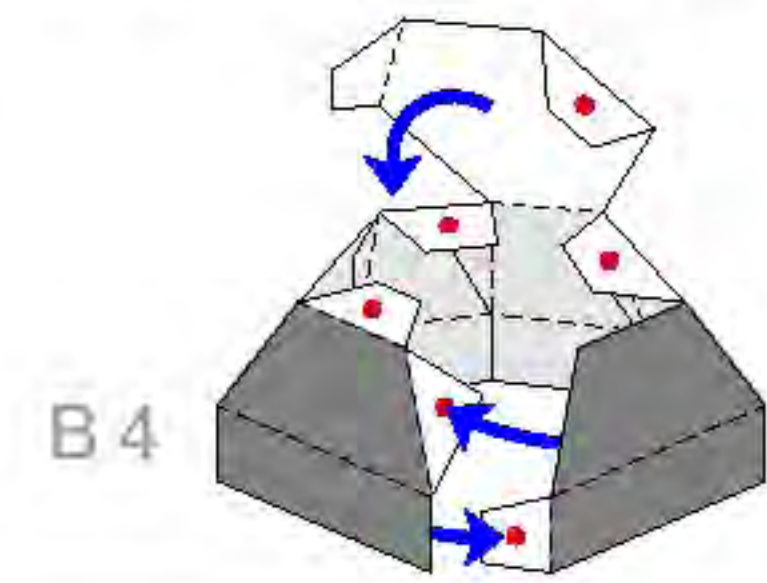

Option 1

1) Cut out B1-B4 and assemble each part.

Fold B1-B3 in half, attach the back of each respective side together, and cut each piece out.



As for B4, start assembly by attaching from the sides. As a final step, put the remaining piece on the top like a lid.

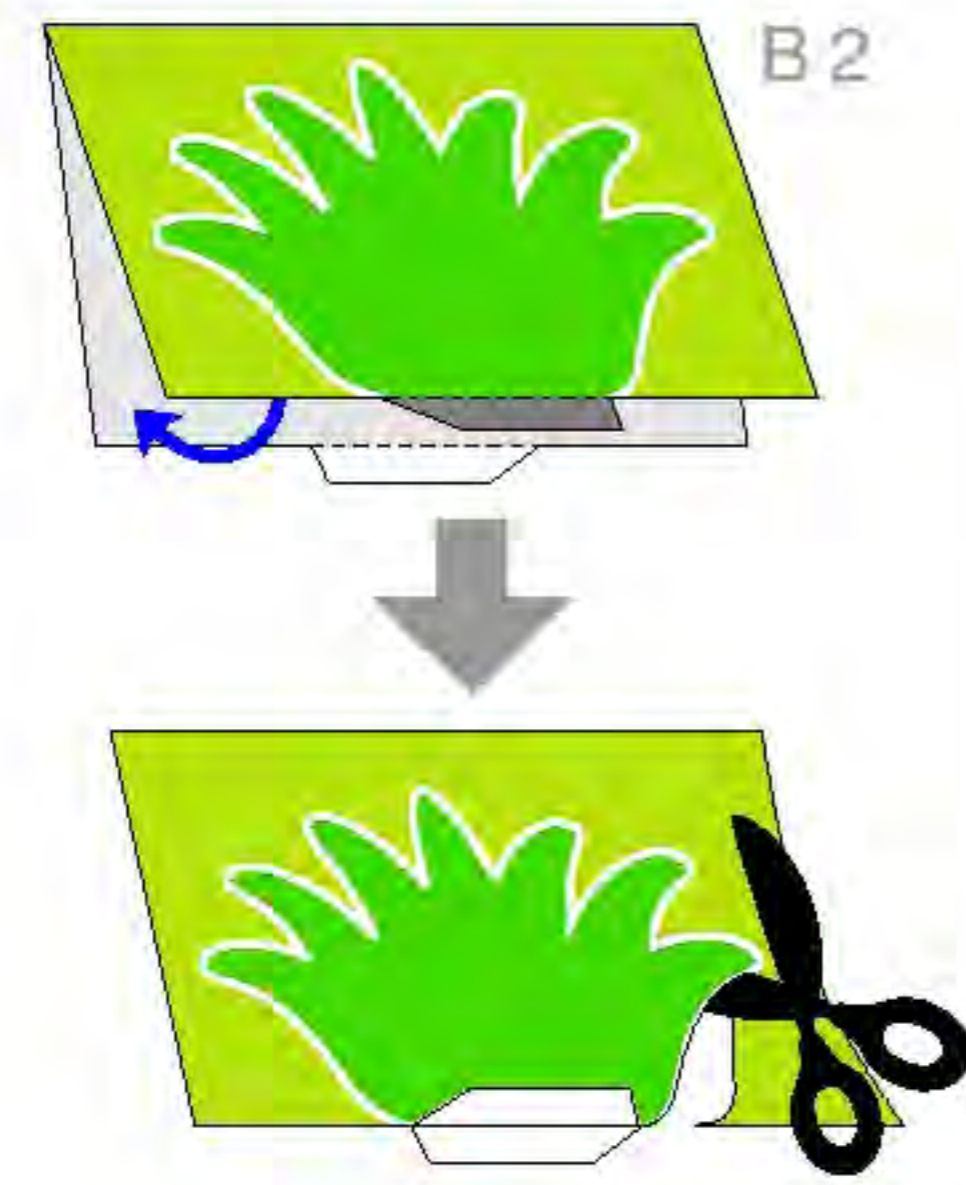

2) Attach B1-B4.

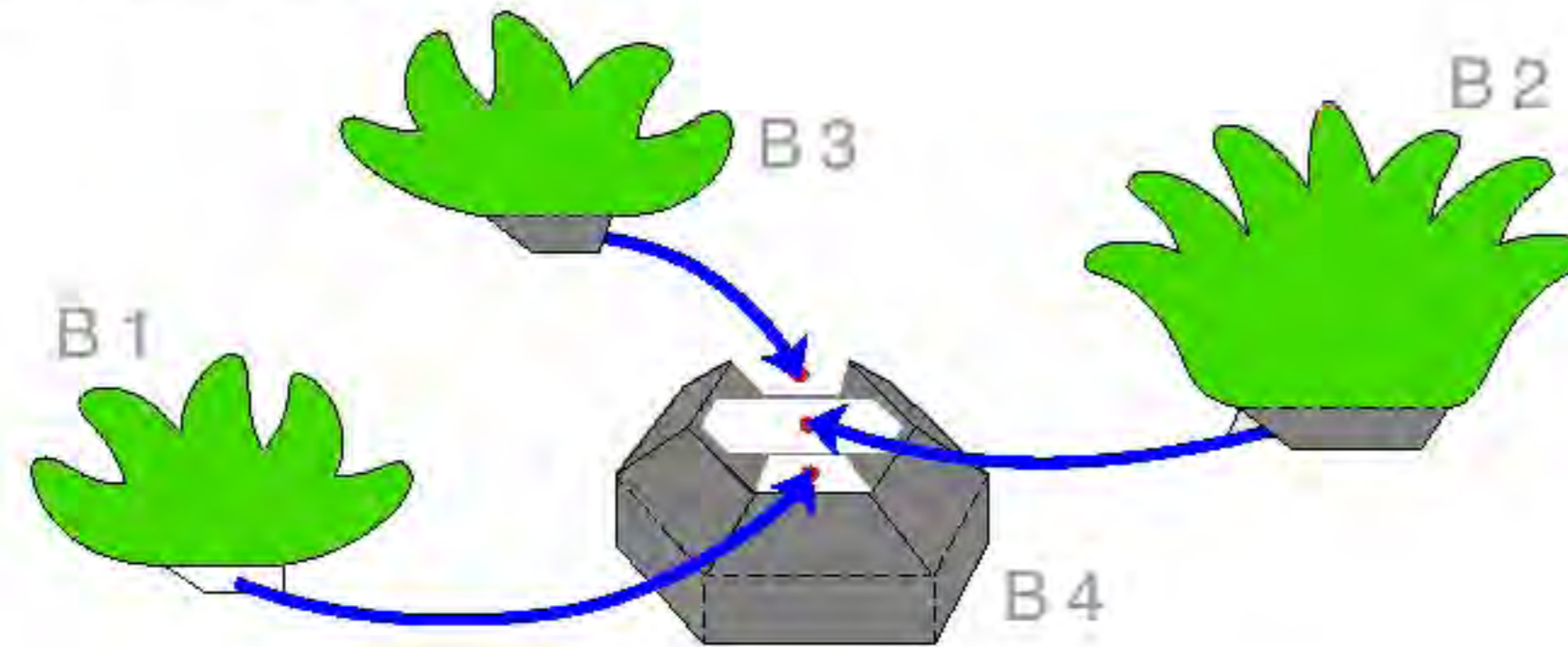

Option 2

1) Cut out C1 and C2 and assemble each part.

Fold C1 in half, attach the back of each respective side together, and cut each piece out.

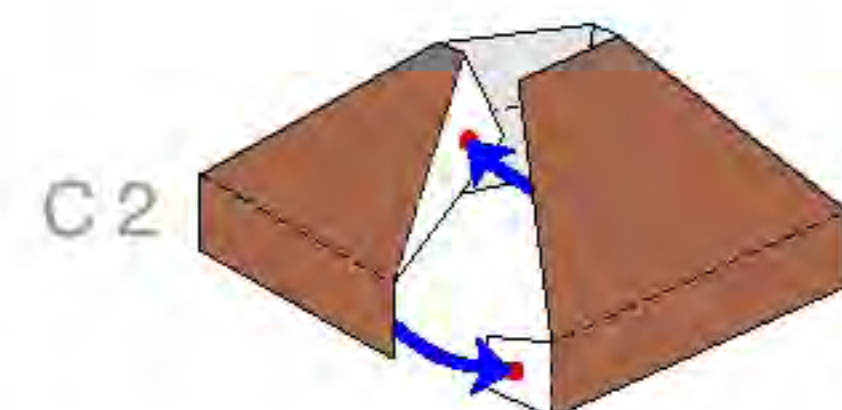

A space will be created on the top of C2.

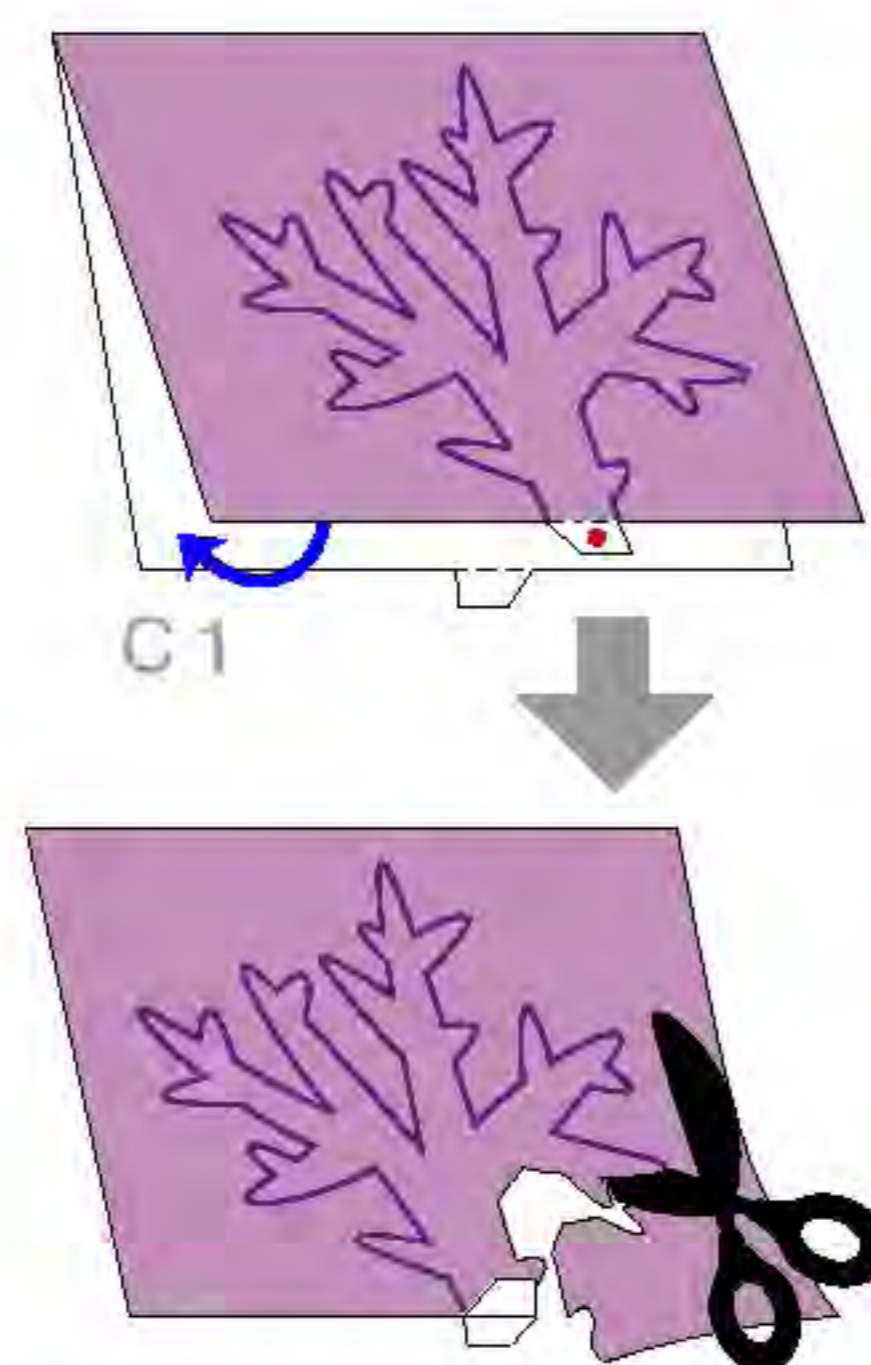

2) Attach C1 and C2.

Insert C1 in C2's space and attach it on the inside.

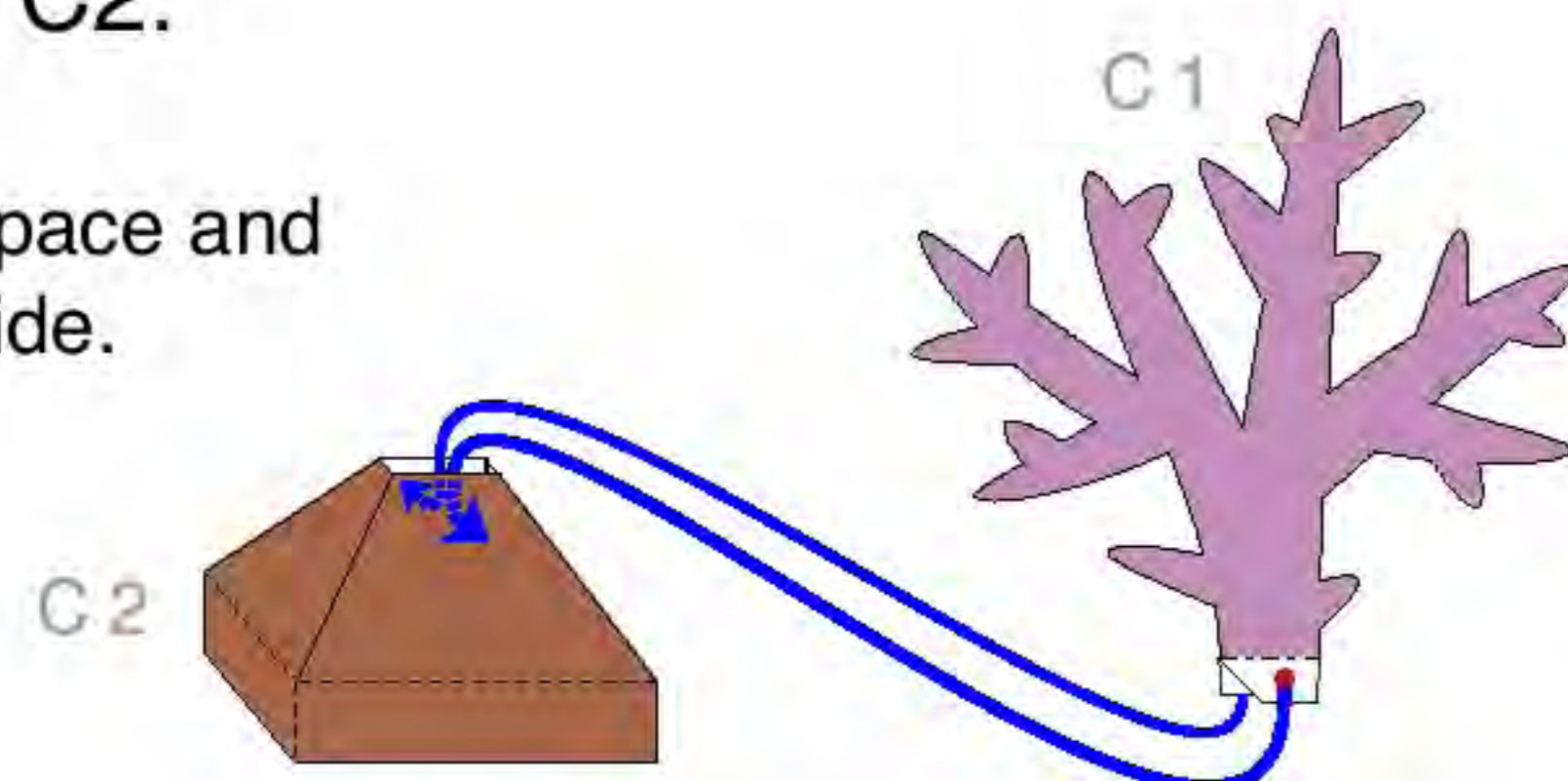

Bluespotted boxfish

1) Cut out D1 and D2, cut along the slots, and assemble the circled parts.

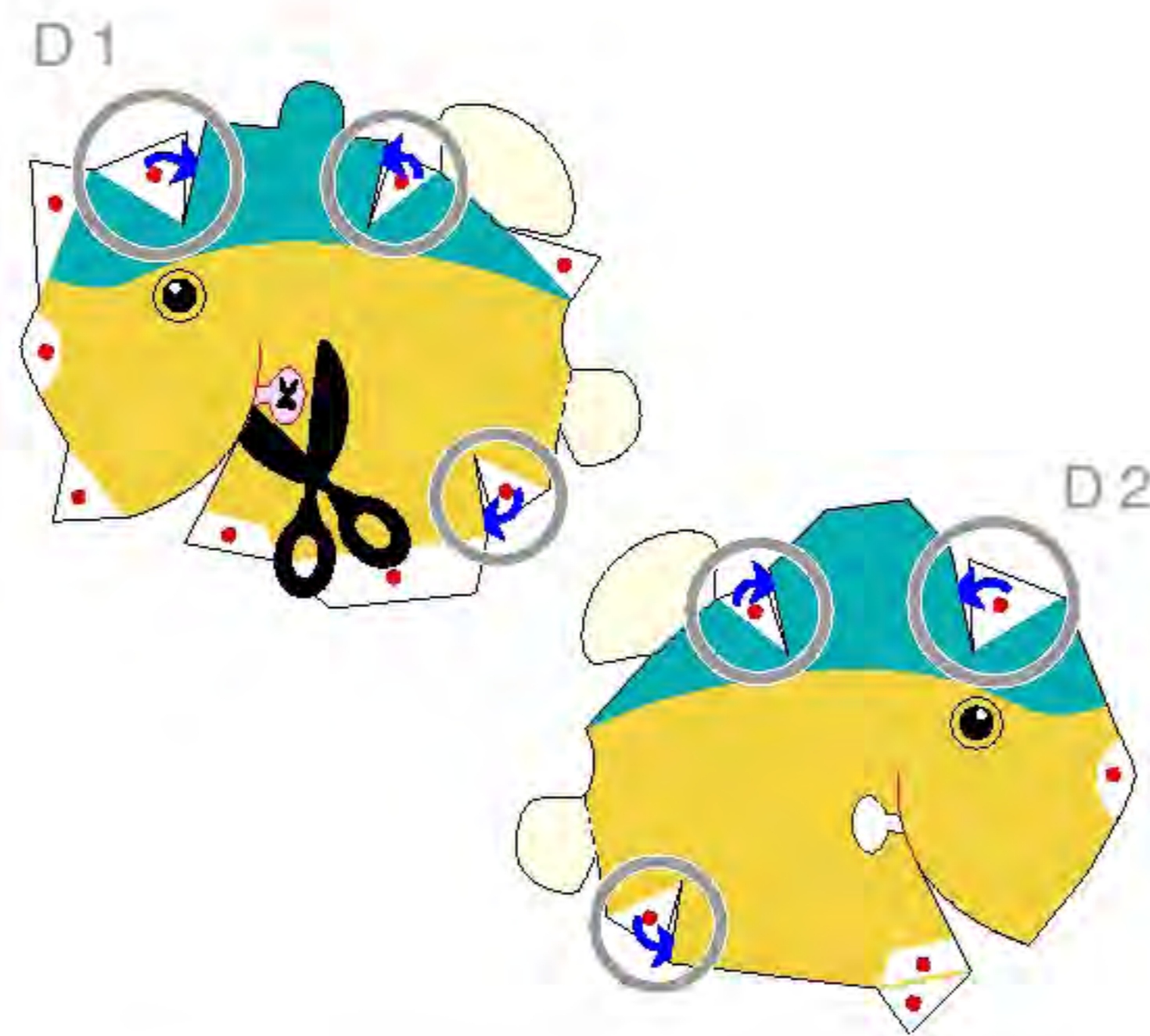

2) Cut out D3-D7 and assemble each part.

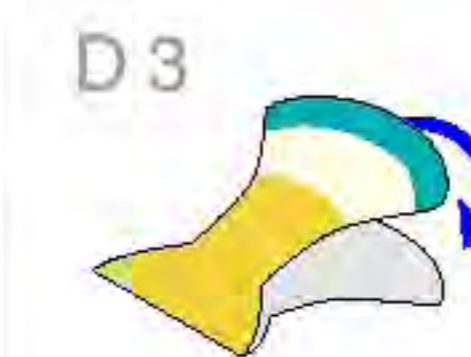

Fold D3-D5 in half and attach the back of each side together respectively.



As for D6, curve it as indicated by the arrow so that it becomes tubular in shape.

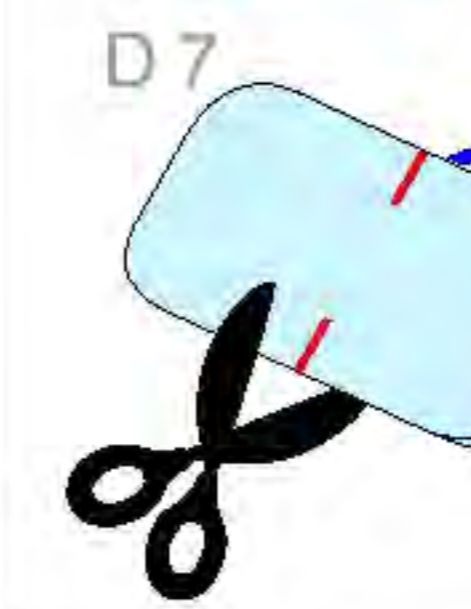

Fold D7 in half, attach the back of each side together, and make incisions.

3) Attach D1-D6.

*Do not attach this part.

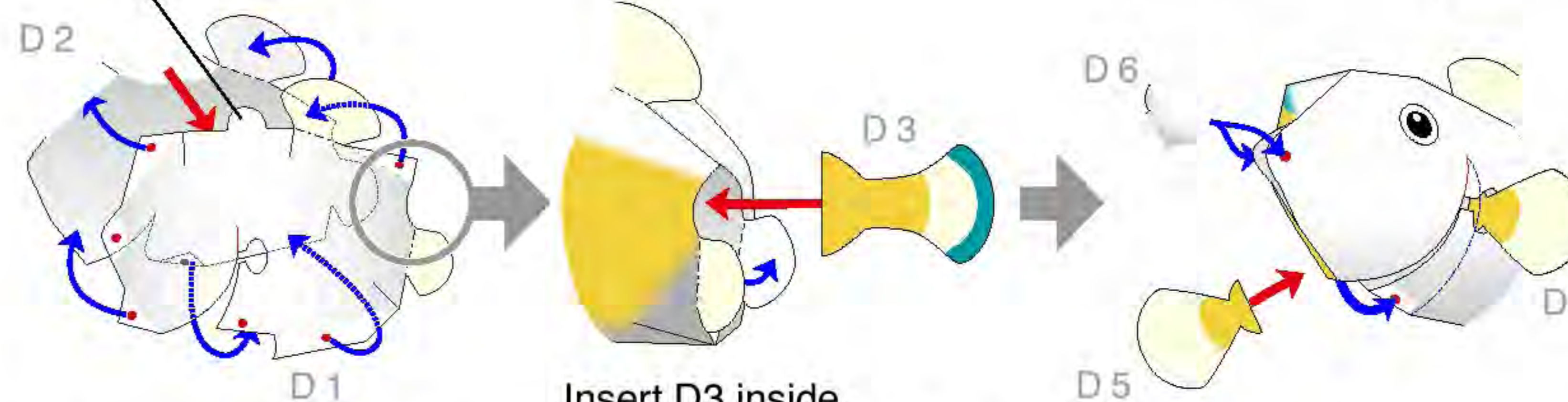

*For the part marked with the arrow, slot it inside D1 without applying glue.

Insert D3 inside, and glue the fin together.

Finally, attach D6.

4) Attach the string and D7 on the bluespotted boxfish.

Cut the string into an approximately 10cm piece.

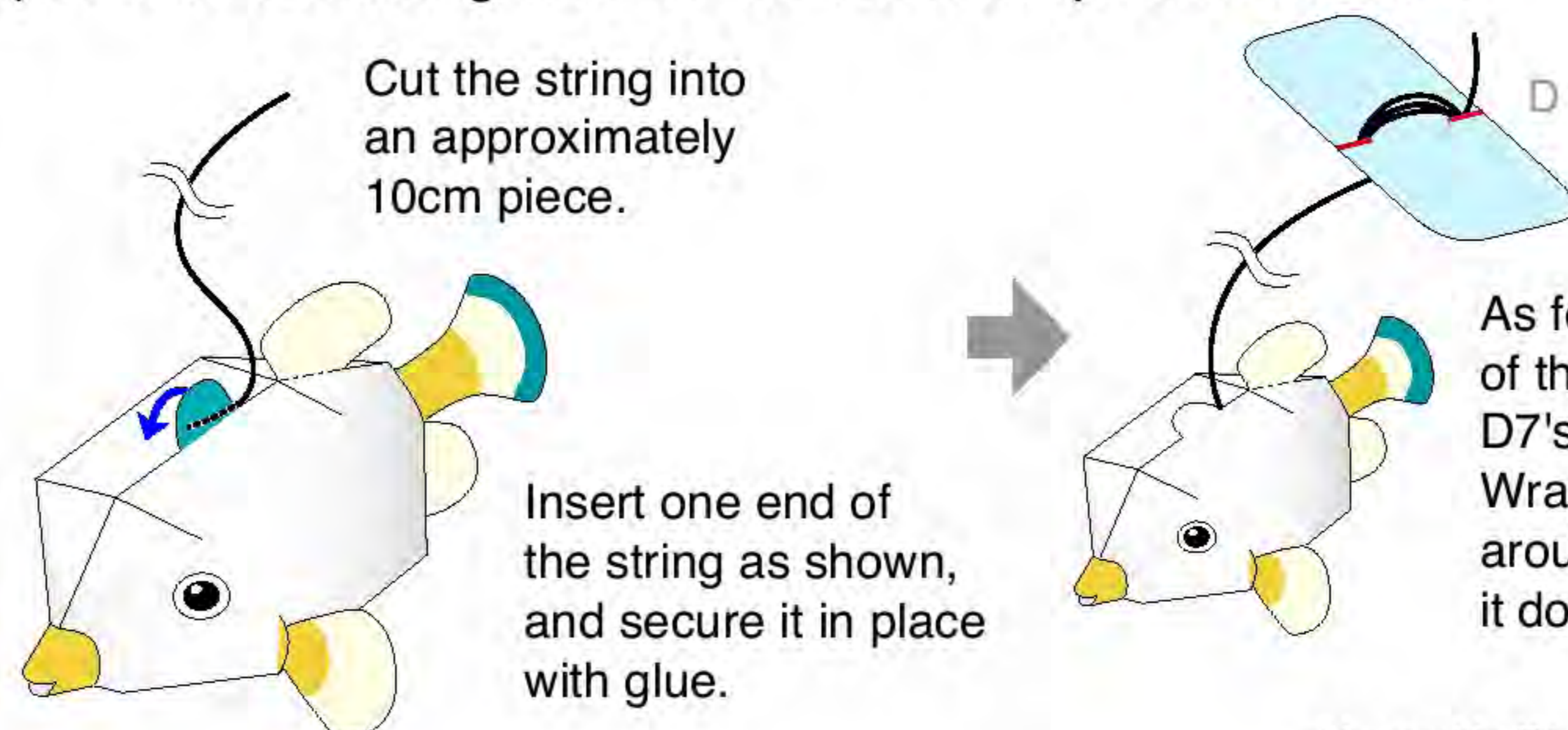

Insert one end of the string as shown, and secure it in place with glue.

As for the other end of the string, put it in D7's incision. Wrap it several times around D7 so that it doesn't come off.

*Assemble E1~E7 in the same way.

Finish

1) Wrap the bluespotted boxfish's string around D7 as many times as you wish to obtain your desired length.

2) Hook the bluespotted boxfish on the hole found in the upper part of the frame.

3) Arrange Option 1 and Option 2, put the lid (frame A8) on top, and you're done!

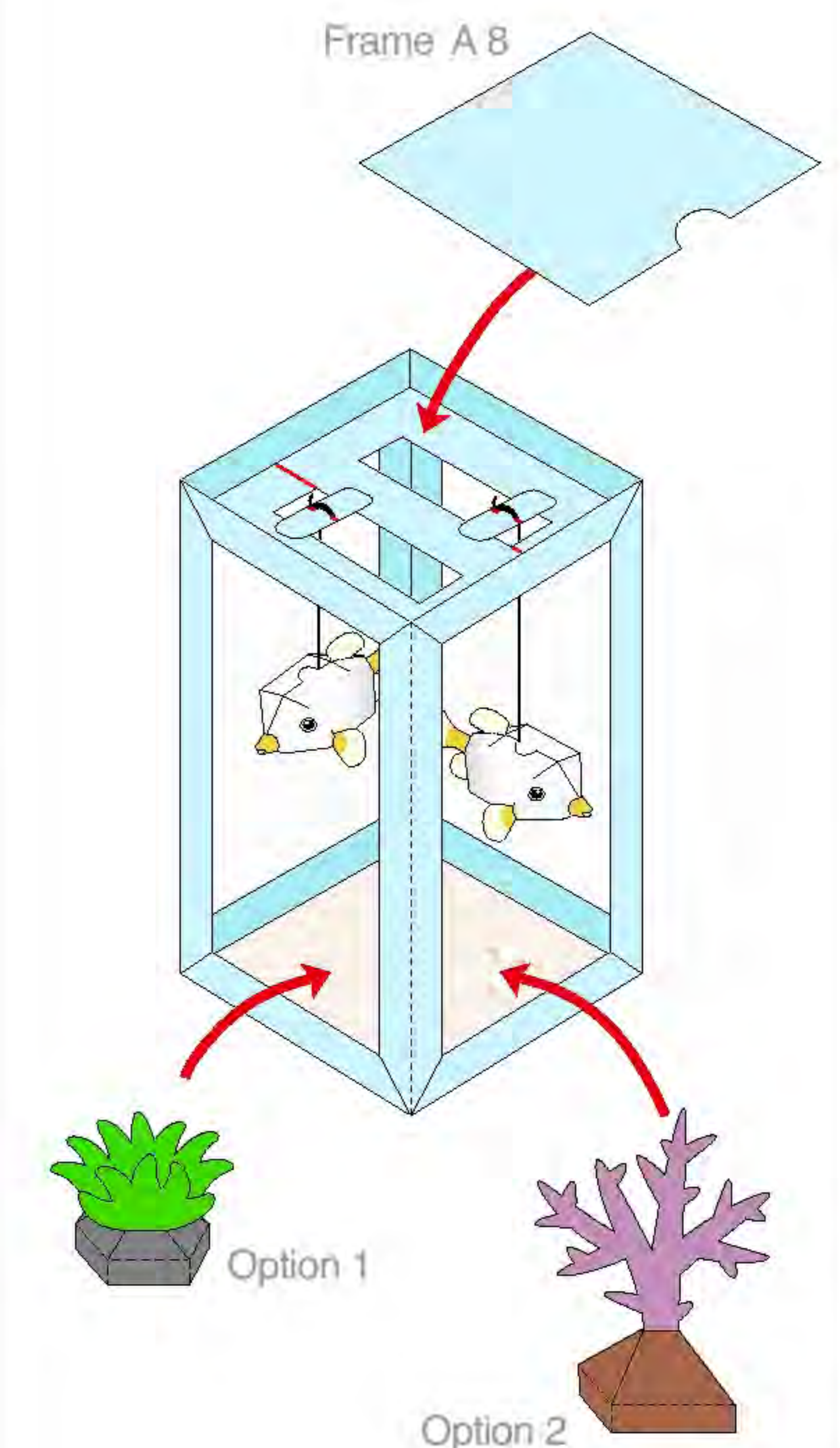



Frame

1) Cut out A1-A5 and assemble each part.

As for A1, fold each side inwardly and glue the back of each side together.

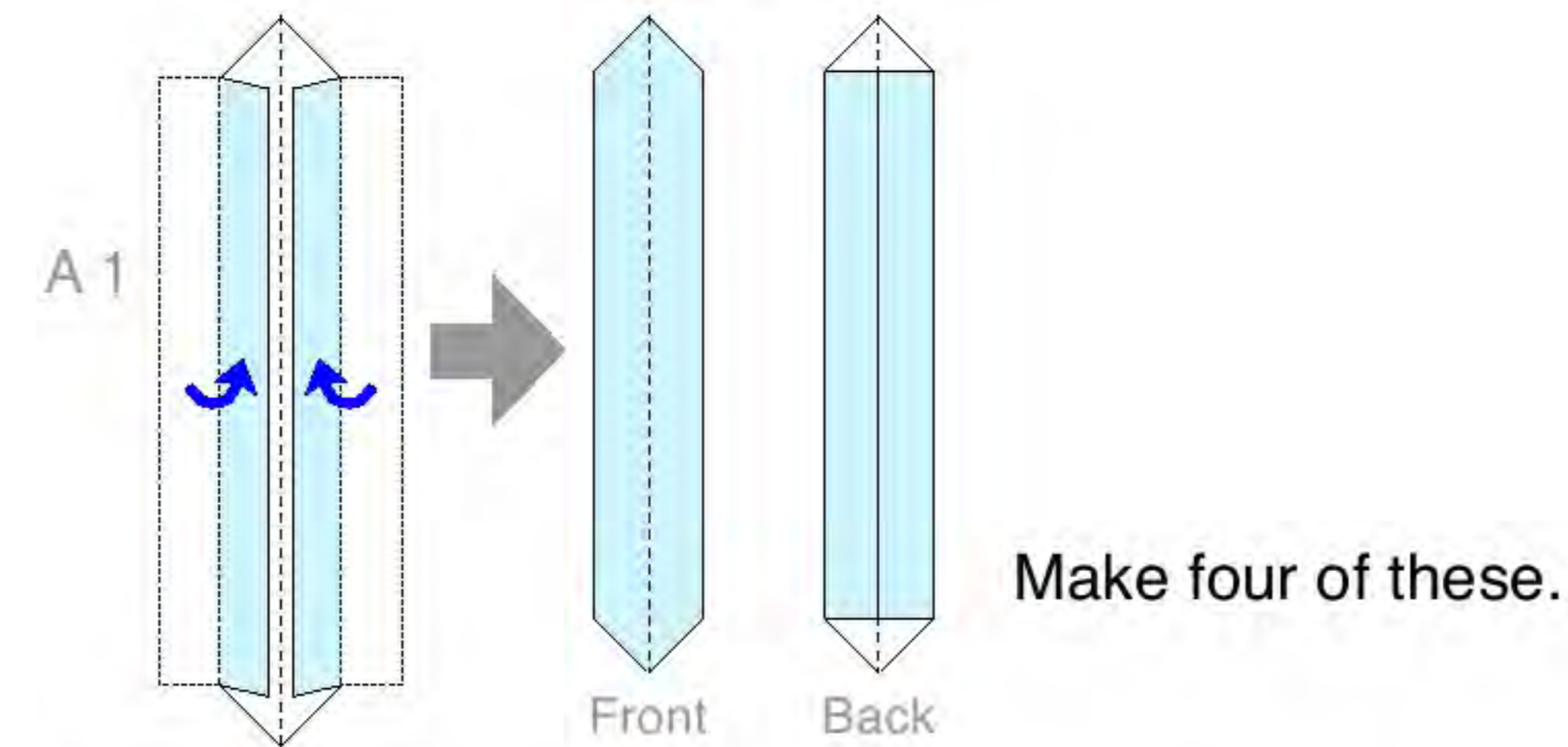

As for A2-A5, fold the upper side inwardly and glue the back of each side together.

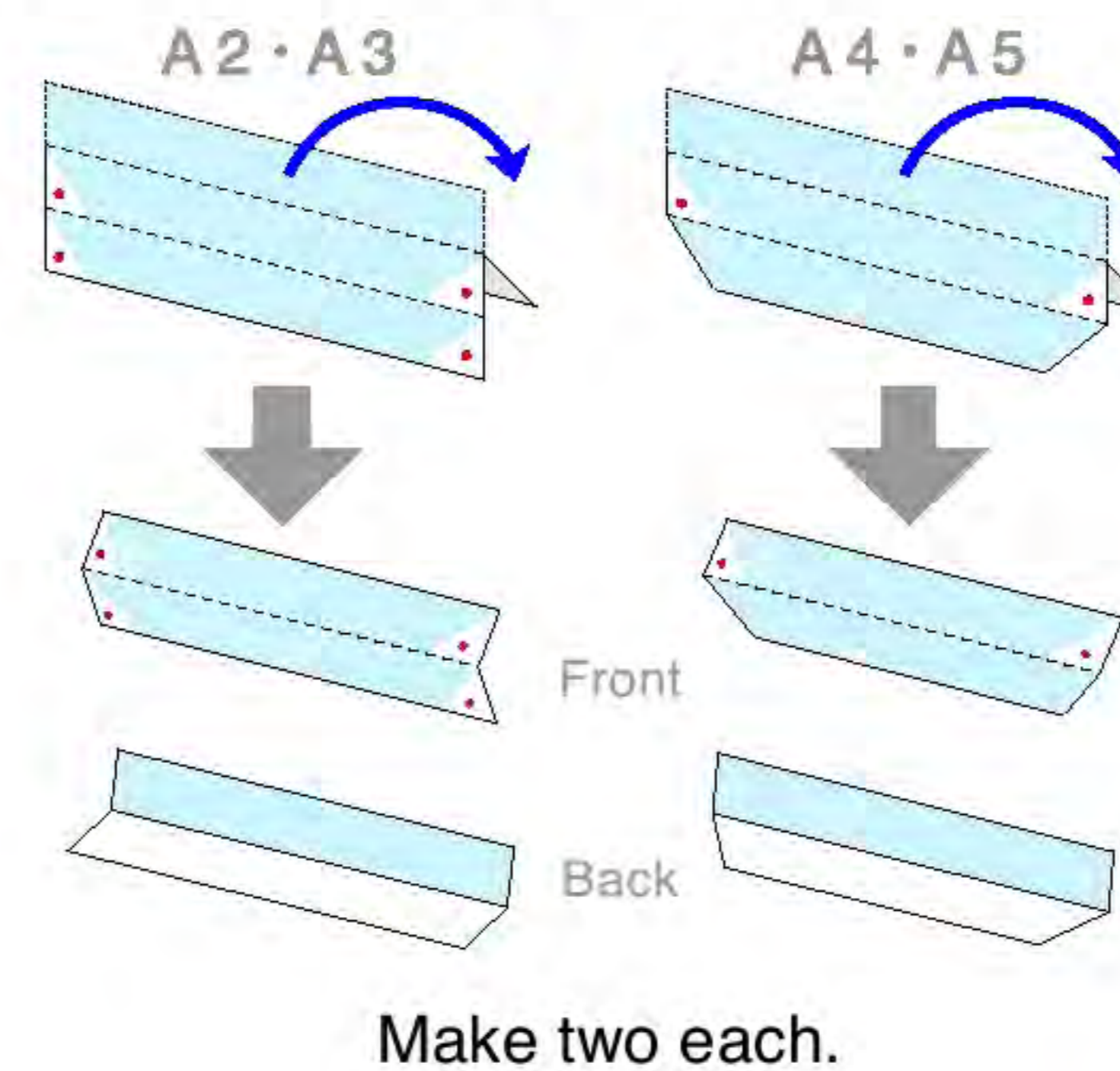

2) Assemble A1-A5.

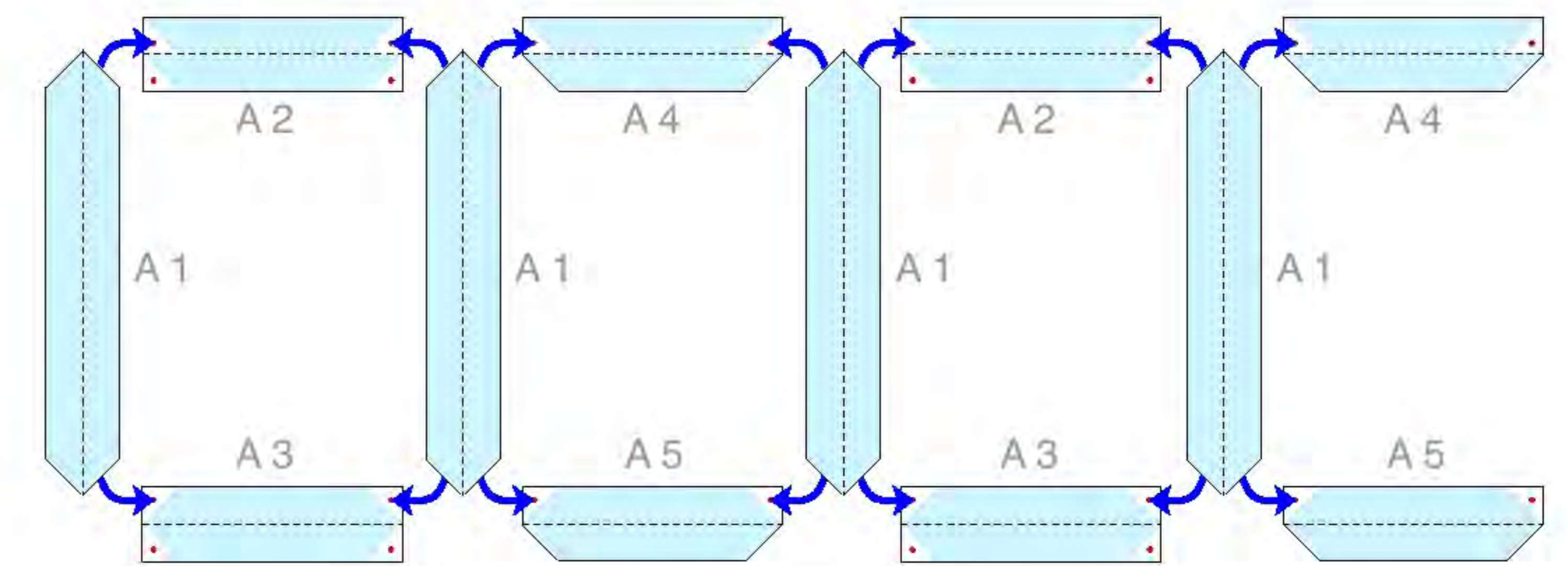

As shown in the diagram, assemble by attaching both ends of A1 to the glue tabs of A2-A5.

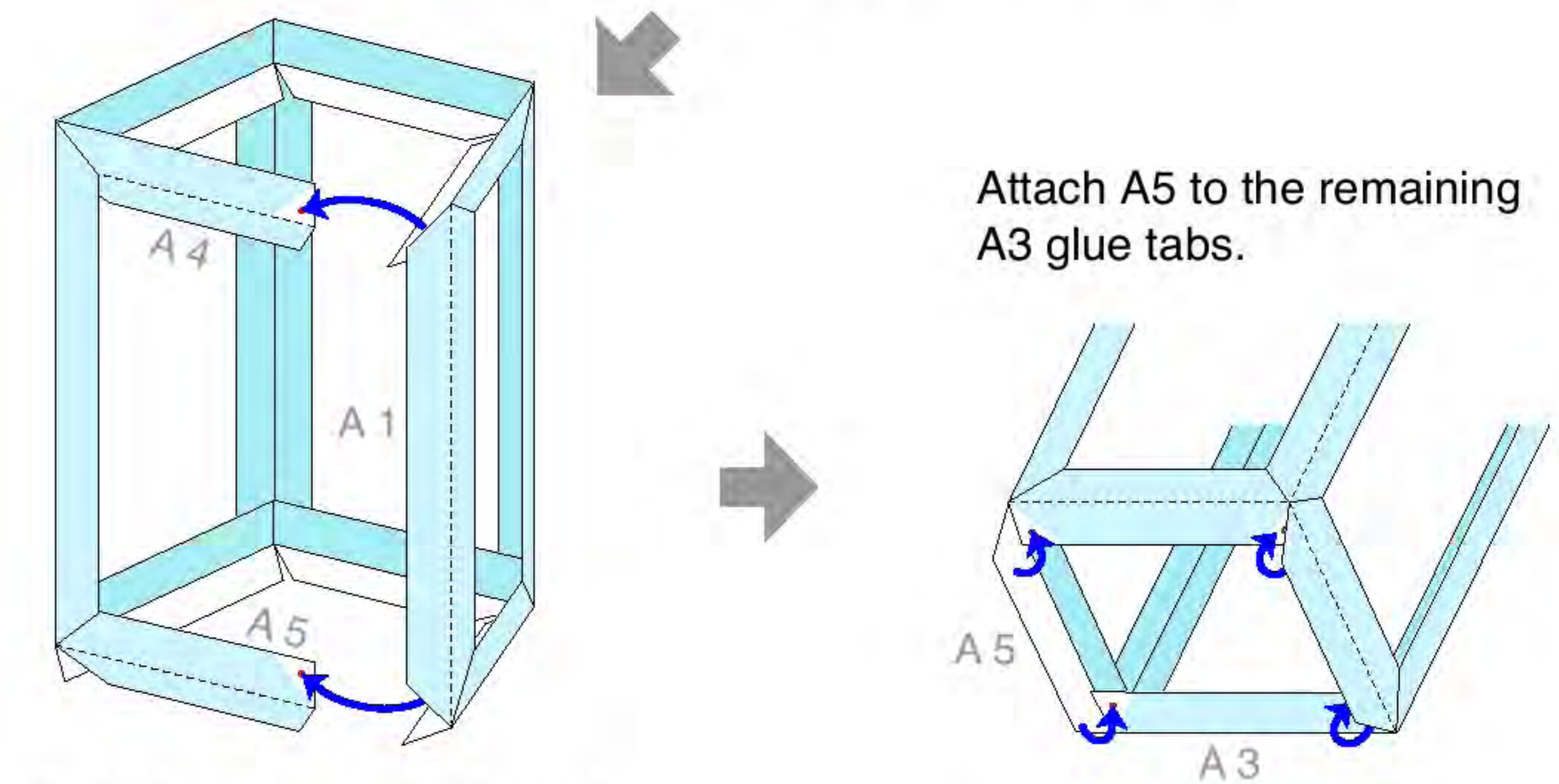

So that it becomes box-shaped, do the same for the ends of A1 and A4/A5.

Attach A5 to the remaining A3 glue tabs.

Likewise, attach A4 to A2.

You will need

Scissors, glue, ruler, a used ball-point pen, white string

Explanation of symbols

- Mountain fold (Dotted line)
- - - - - Valley fold (Dashed and dotted line)
- Cut line (Solid line)
- Cut in line (Red solid line)
- Glue tab
- ✂ Cut out

Assembly tip

Trace along the folds with a ruler and a used pen (no ink) to get a sharper, easier fold.

Caution: This craft requires the use of glue, scissors, and other tools which may be dangerous to young children. Please keep them out of reach of children while you work.

3) Cut out A6-A8 and assemble each part.

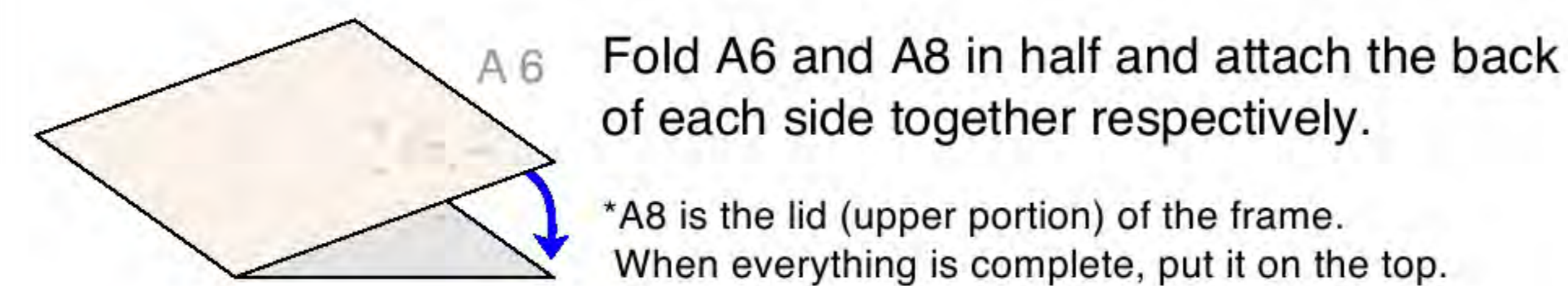

*A8 is the lid (upper portion) of the frame. When everything is complete, put it on the top.

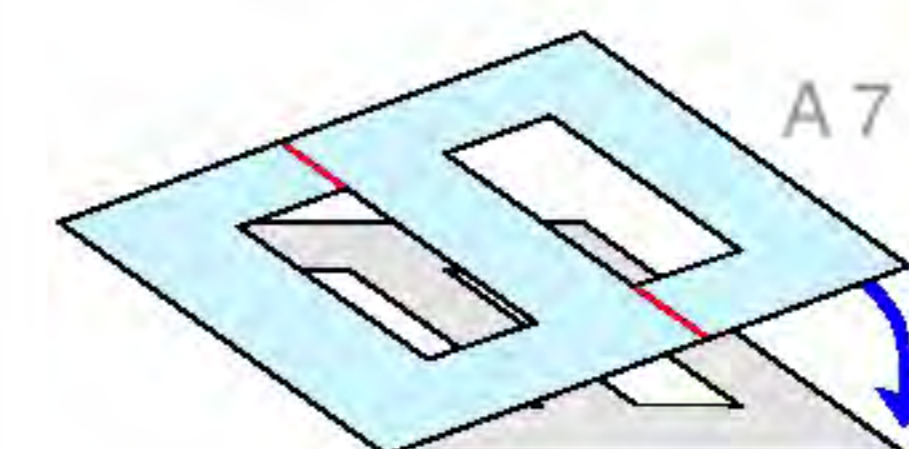
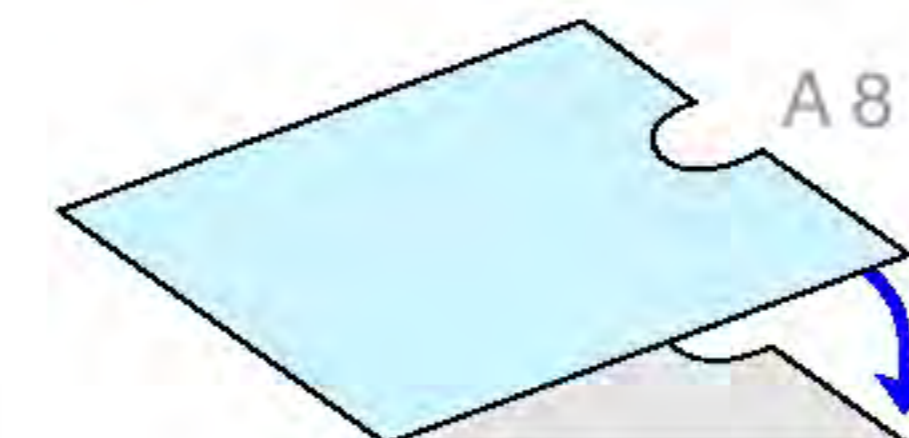

As for A7, cut along the cut line and fold it in half after cutting out the designated area. Then attach the sides together.

4) Assemble A6 and A7 to the frame you've already completed.

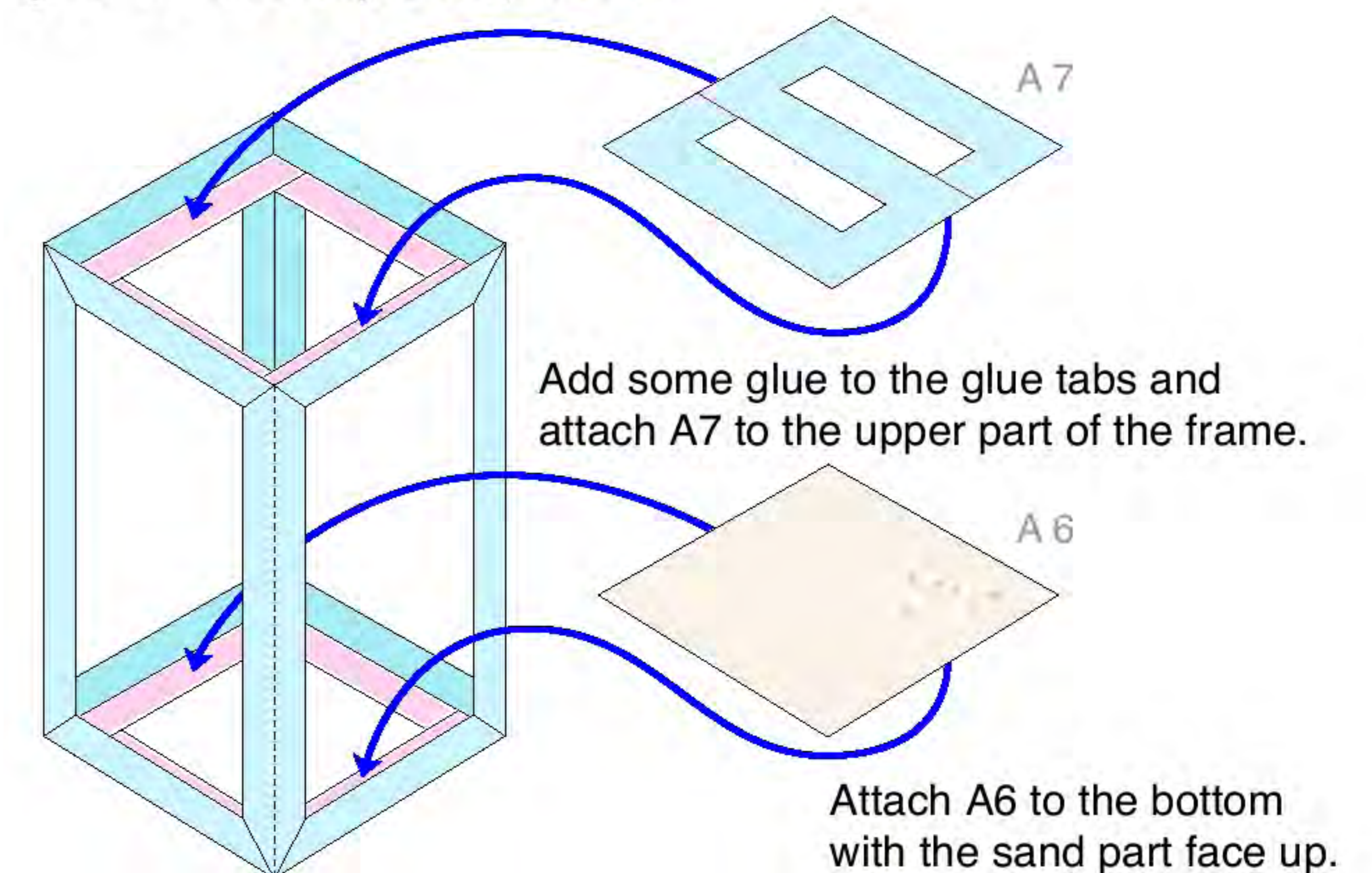

Attach A6 to the bottom with the sand part face up.

A 1

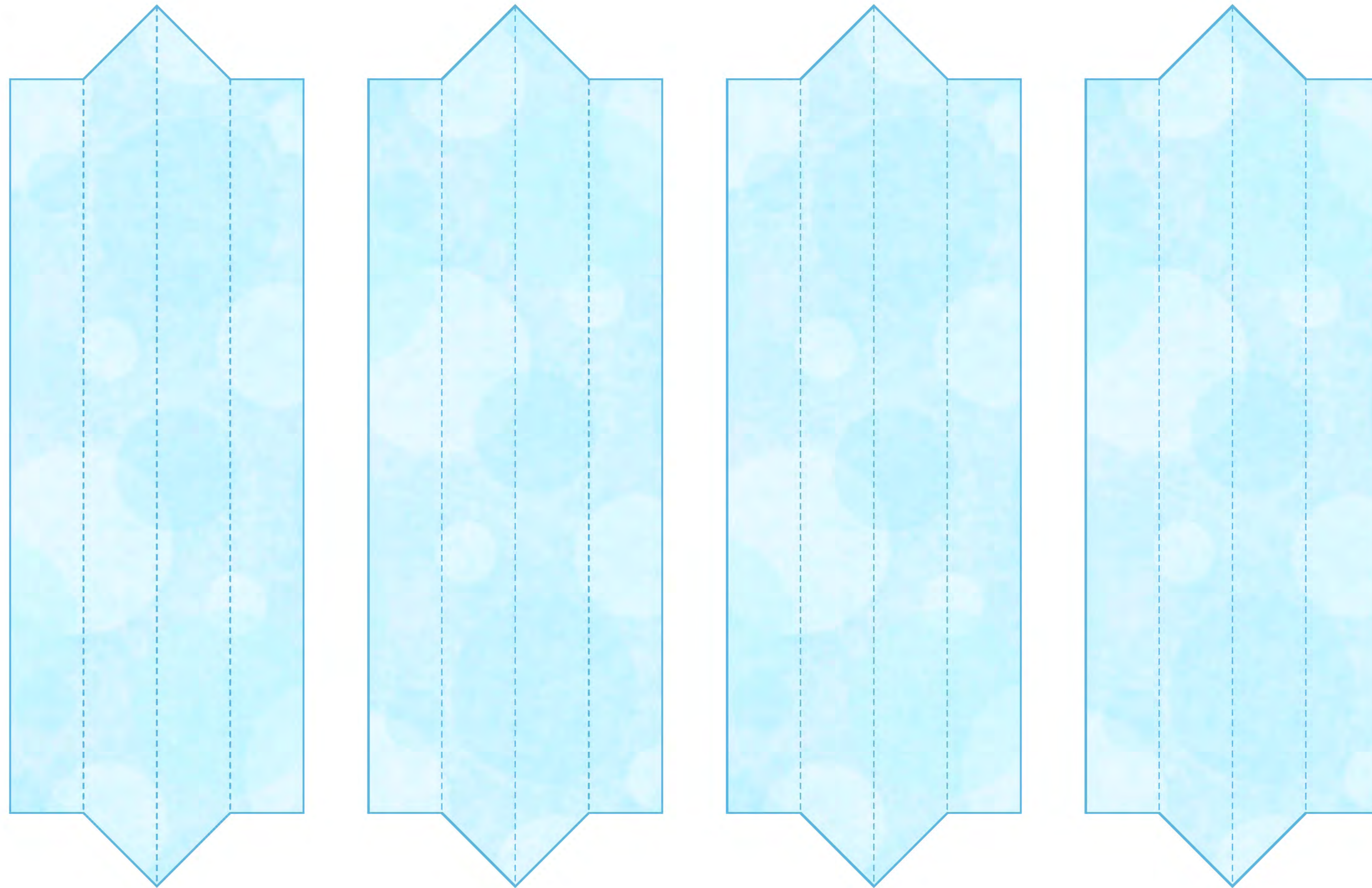

A 2

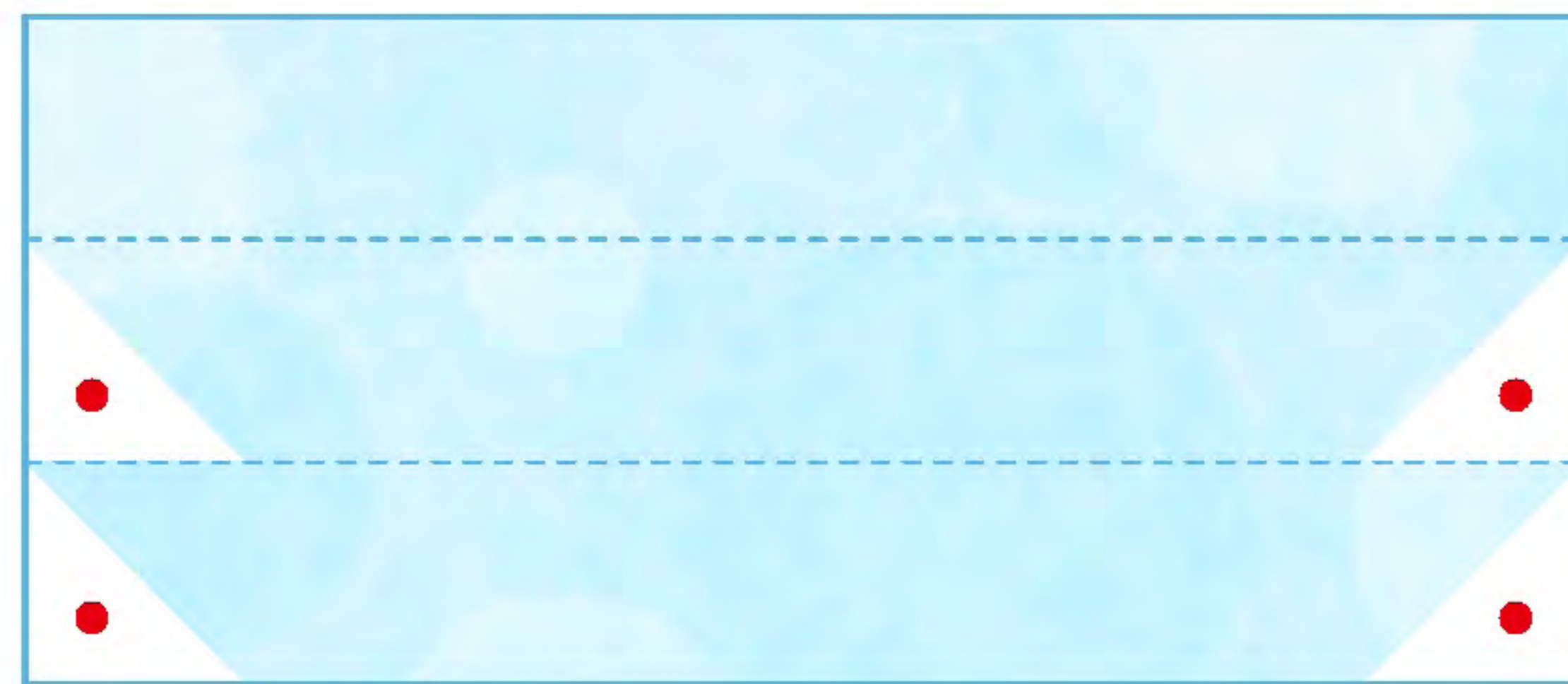
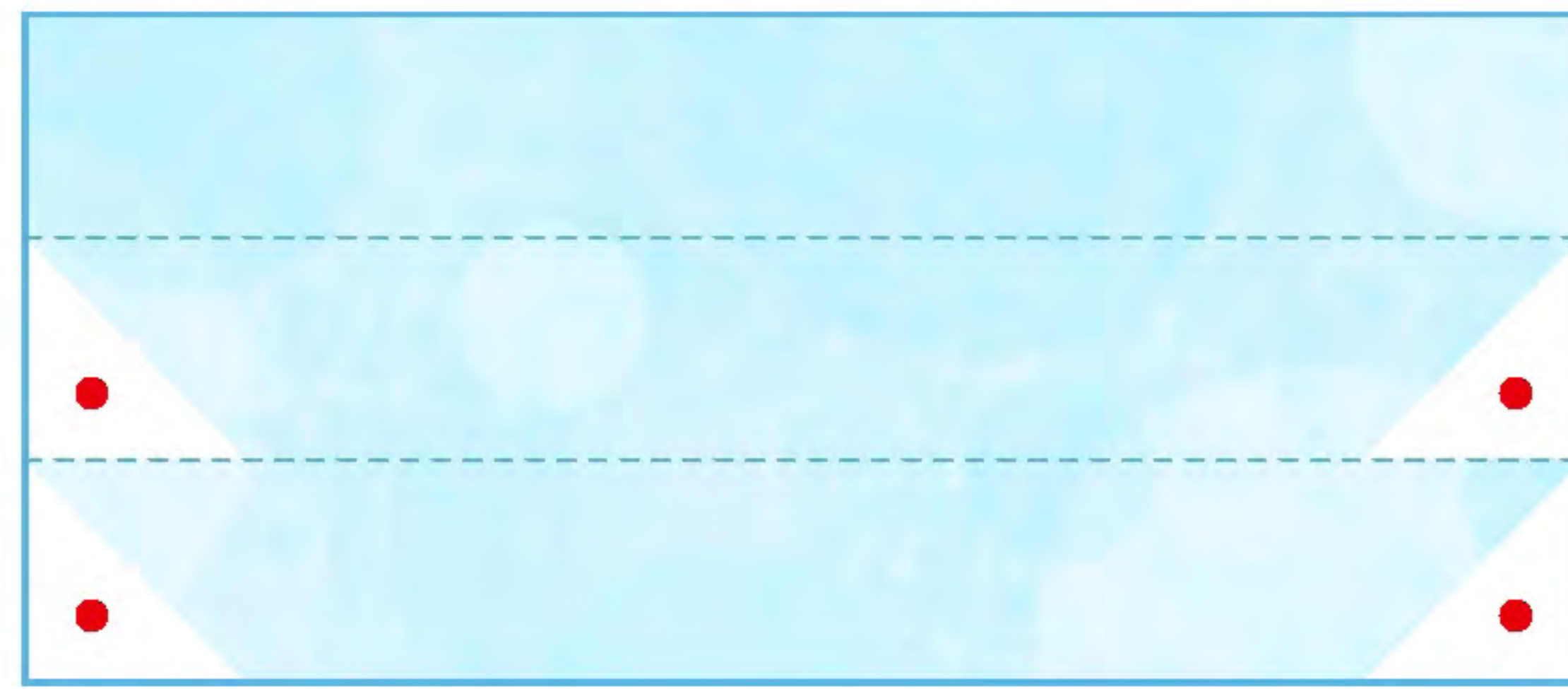

A 3

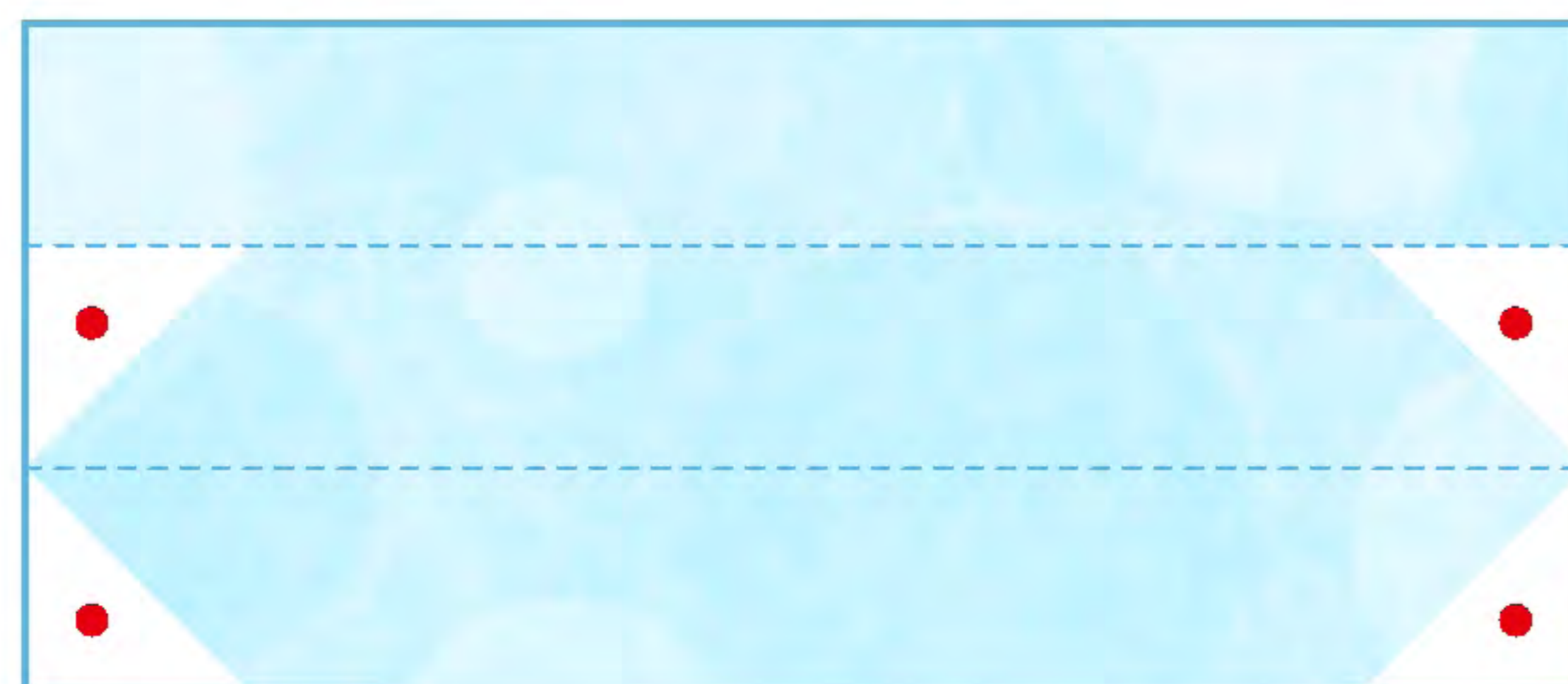
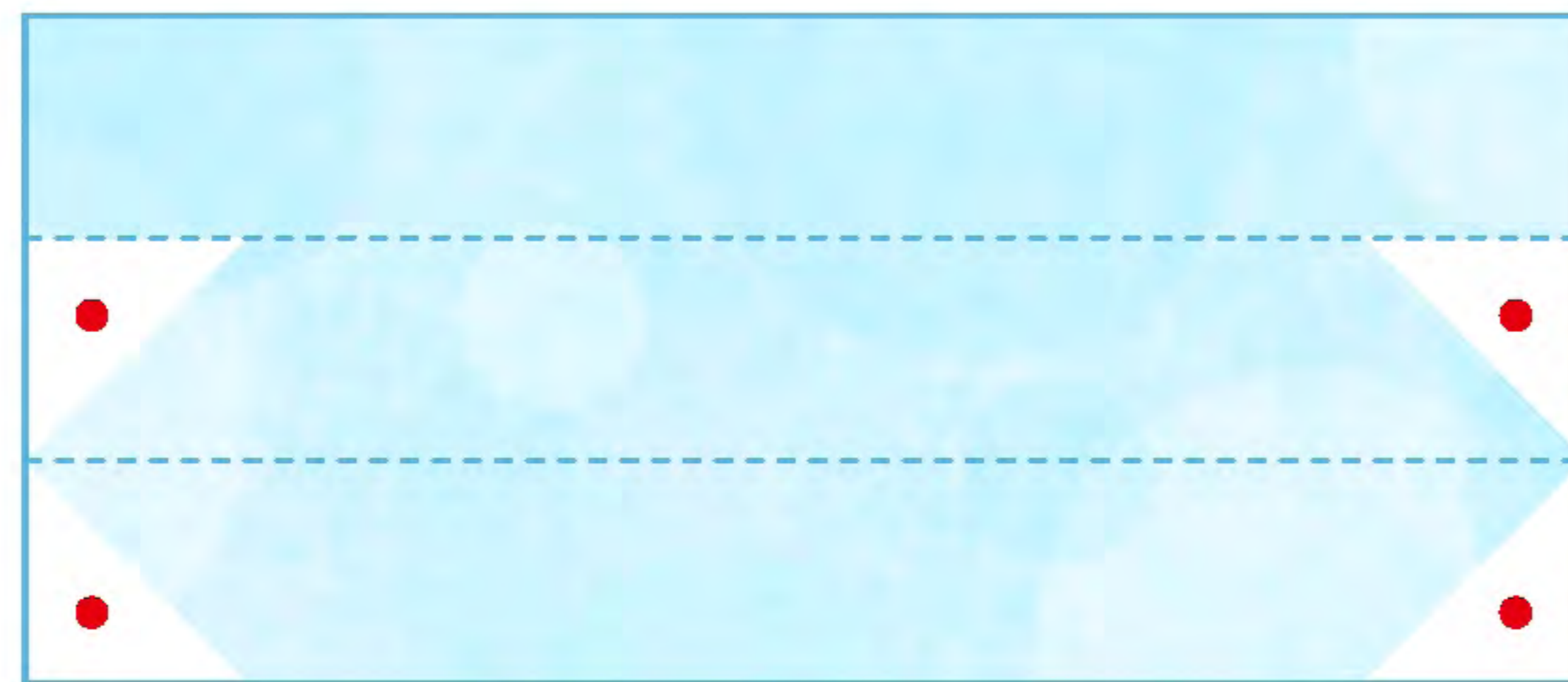

A 4

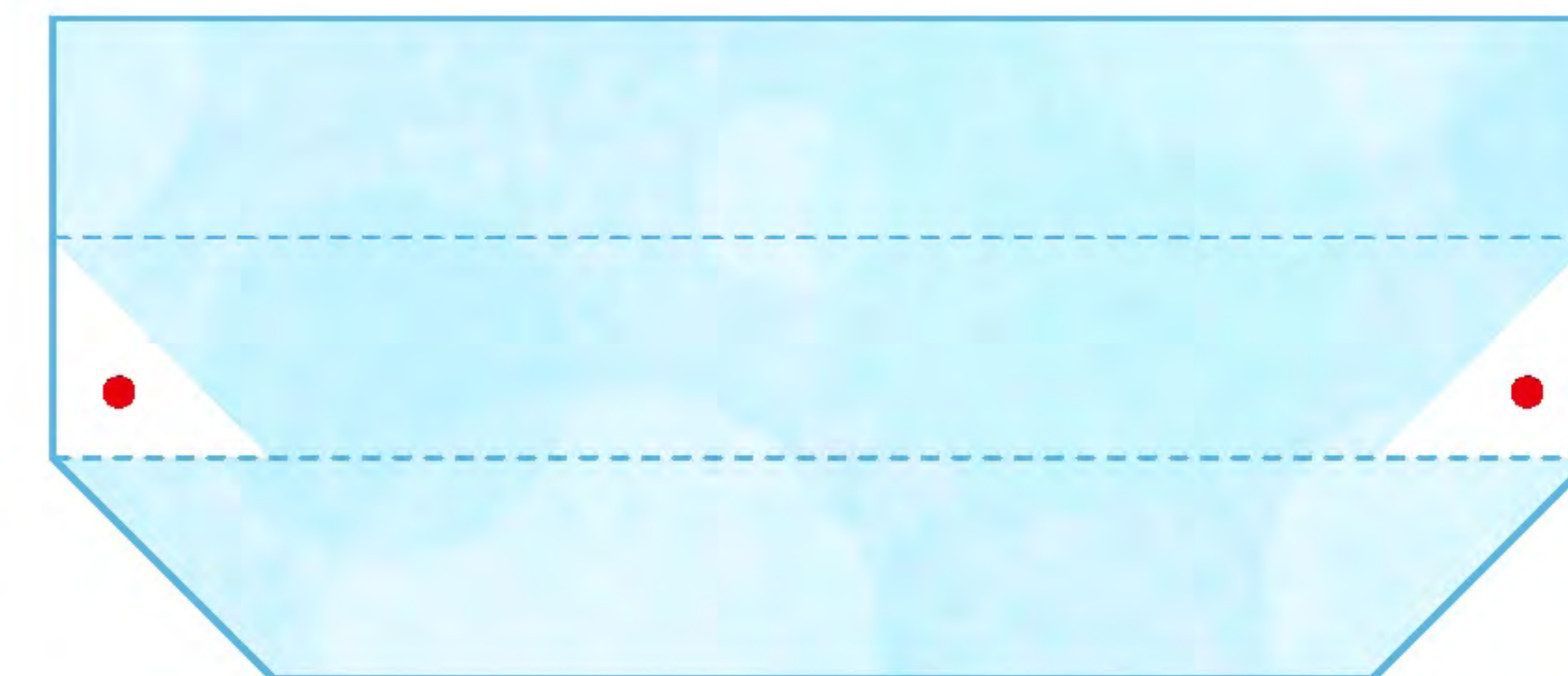
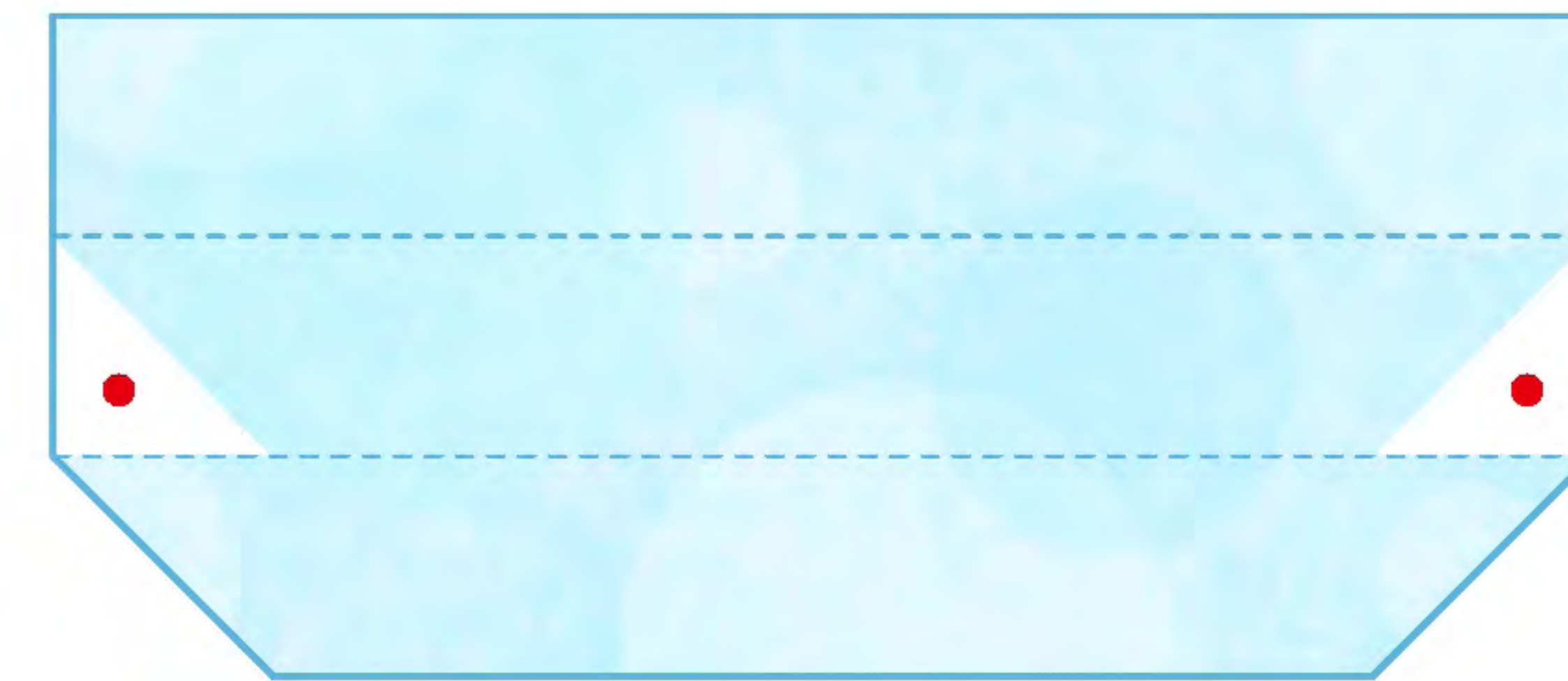

A 5

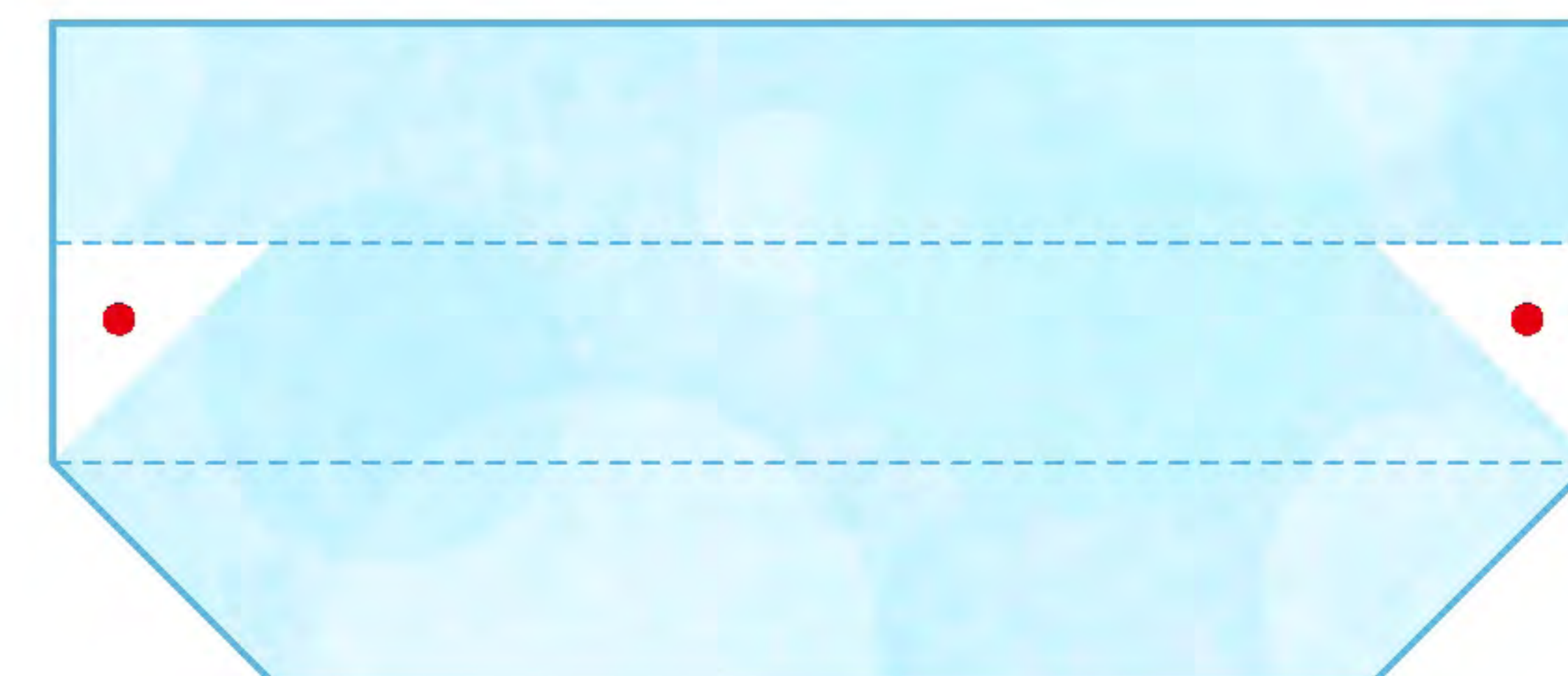
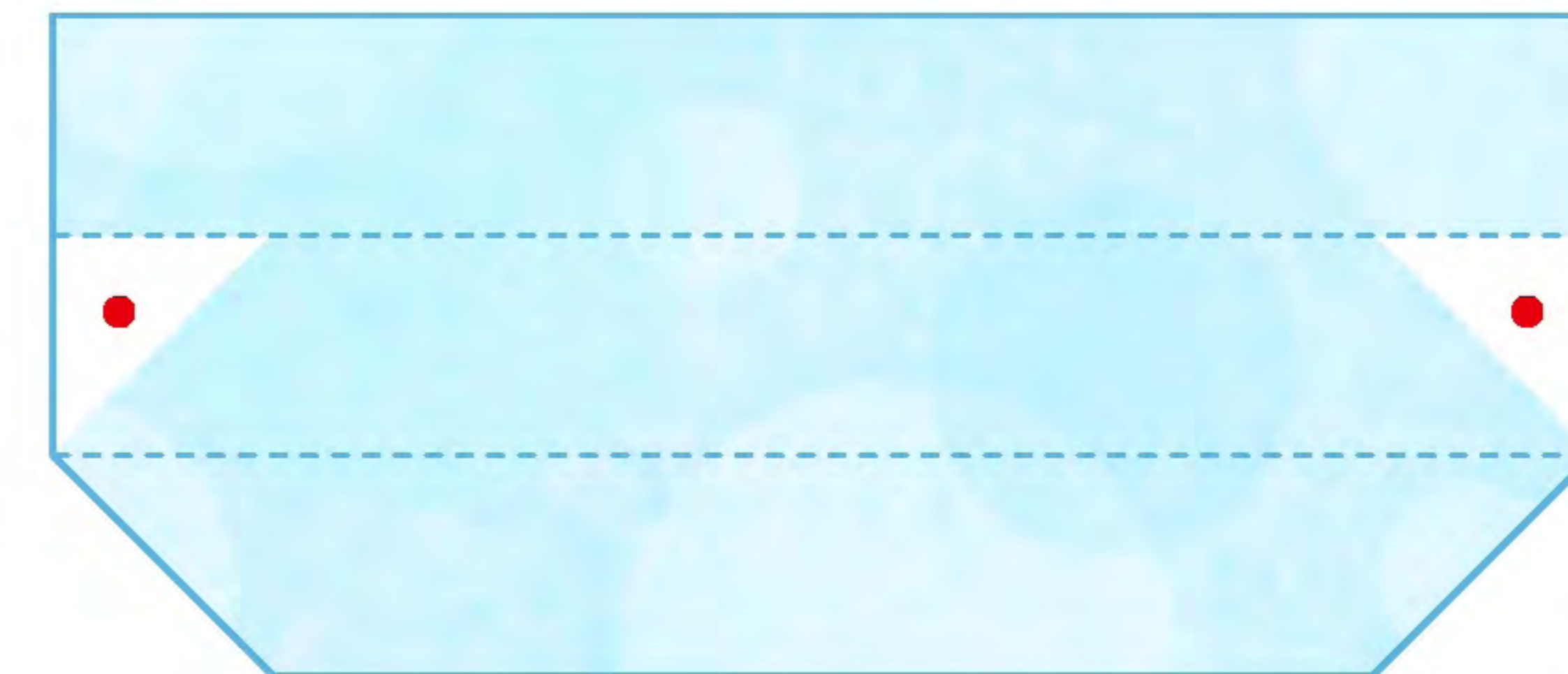

A 6

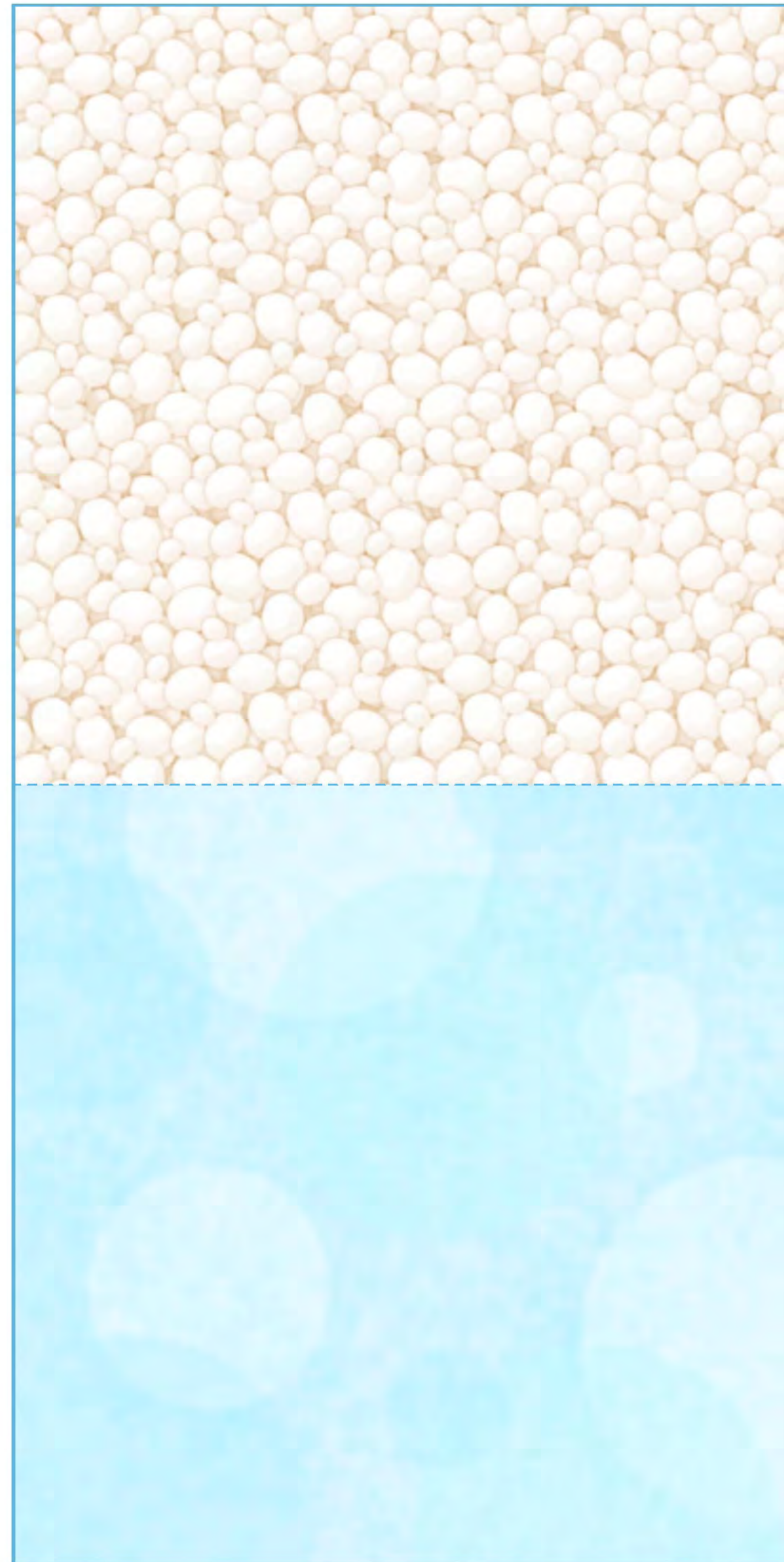

A 7

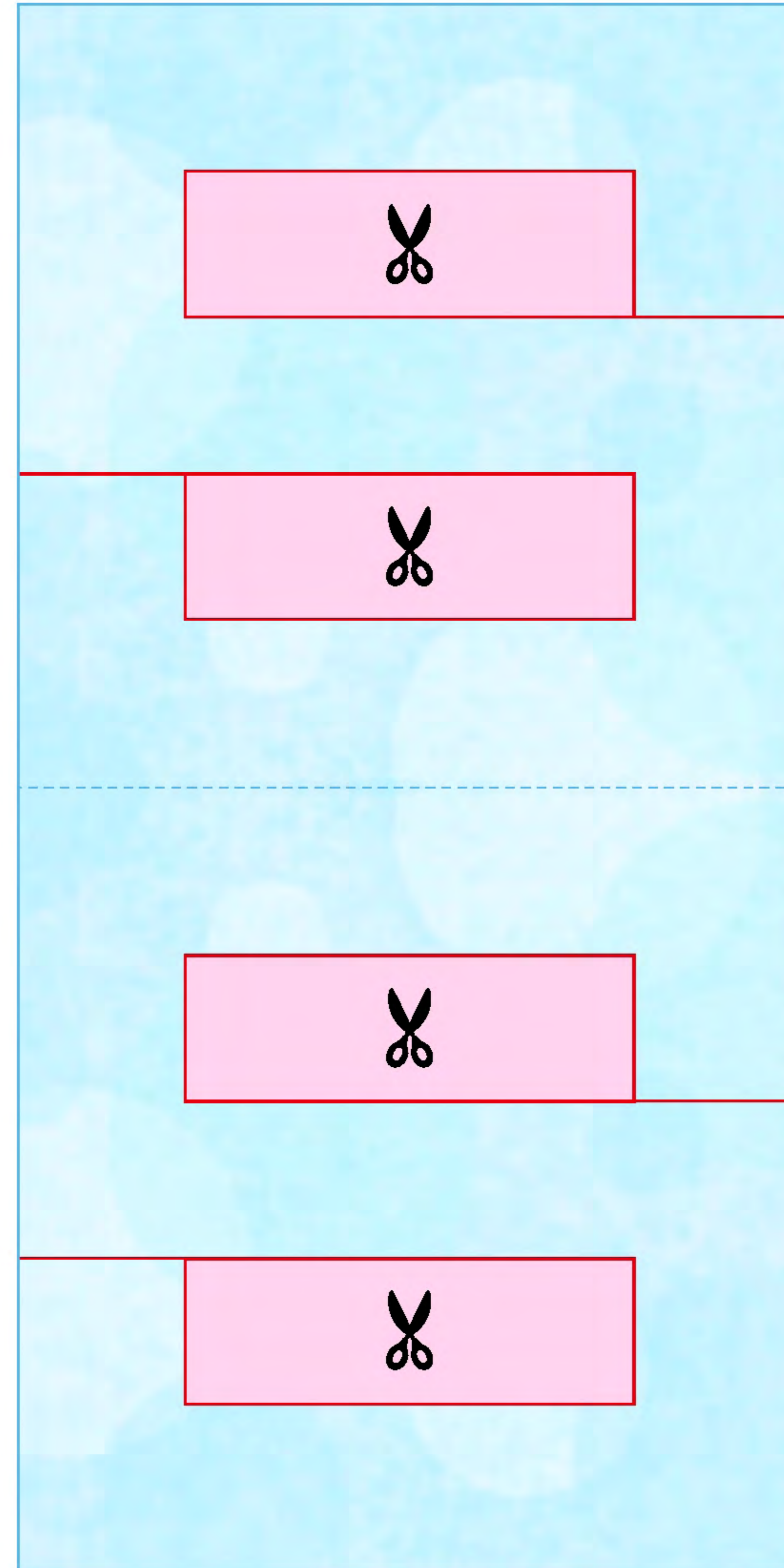

A 8



B 1

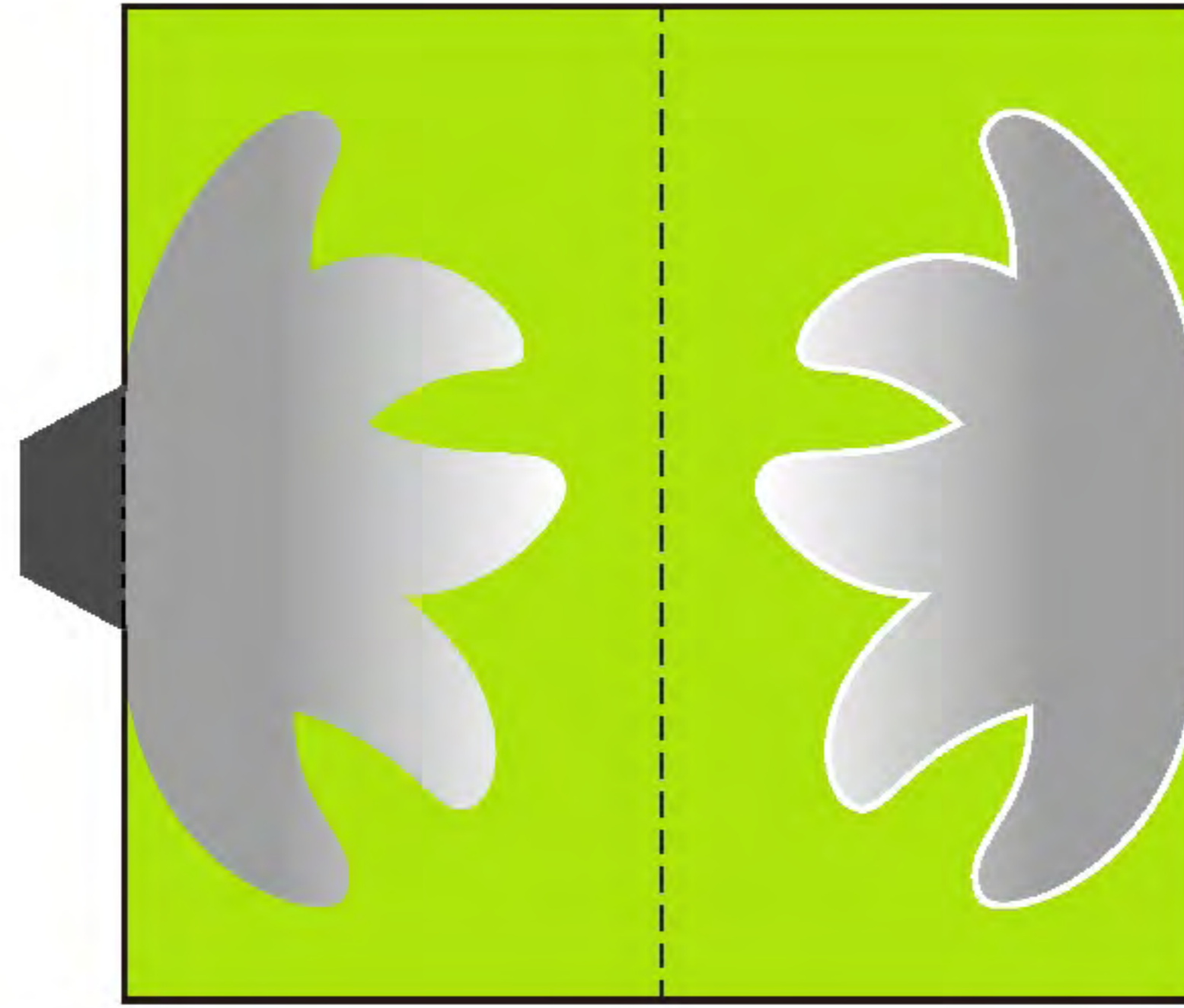

B 3

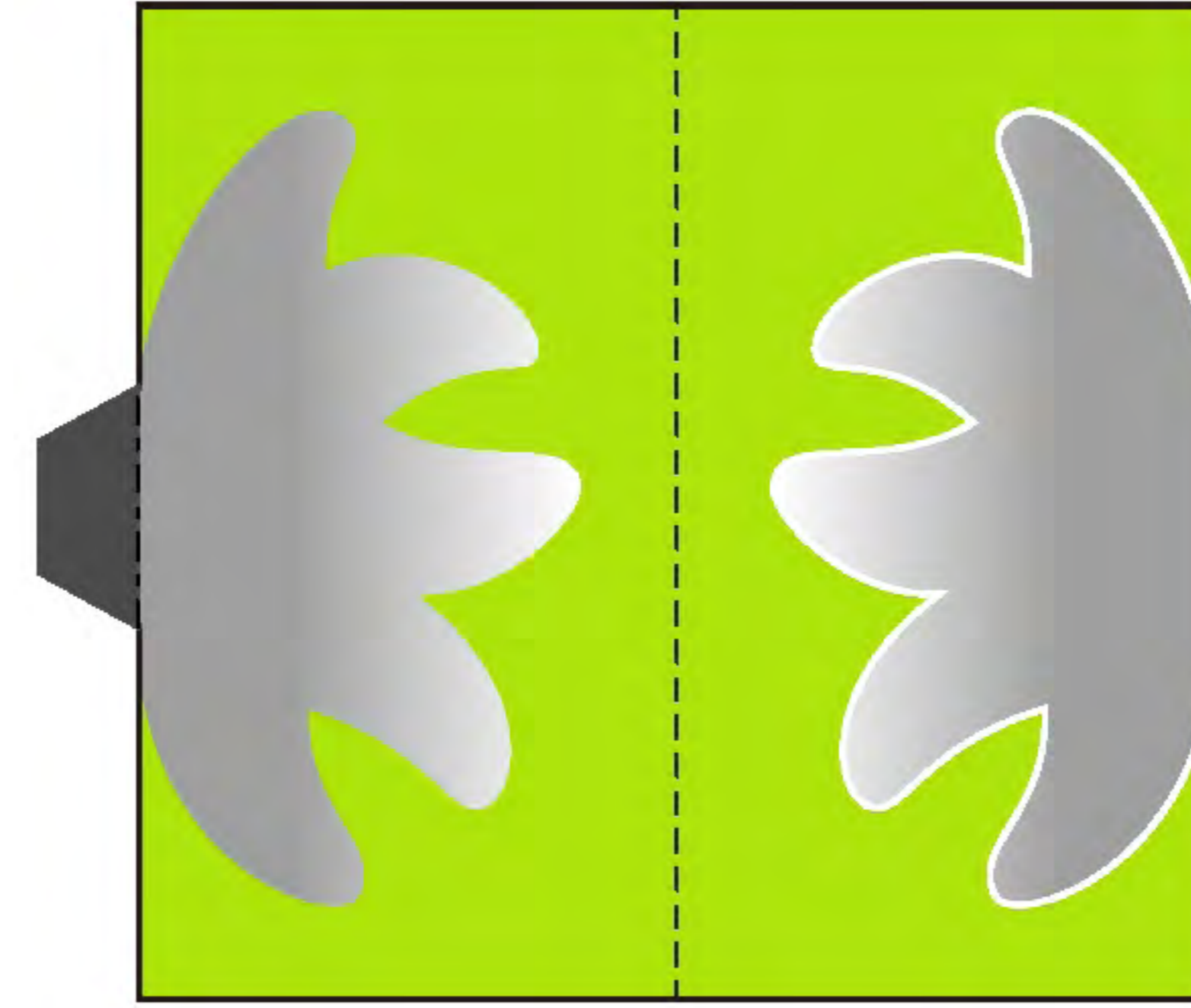

B 2

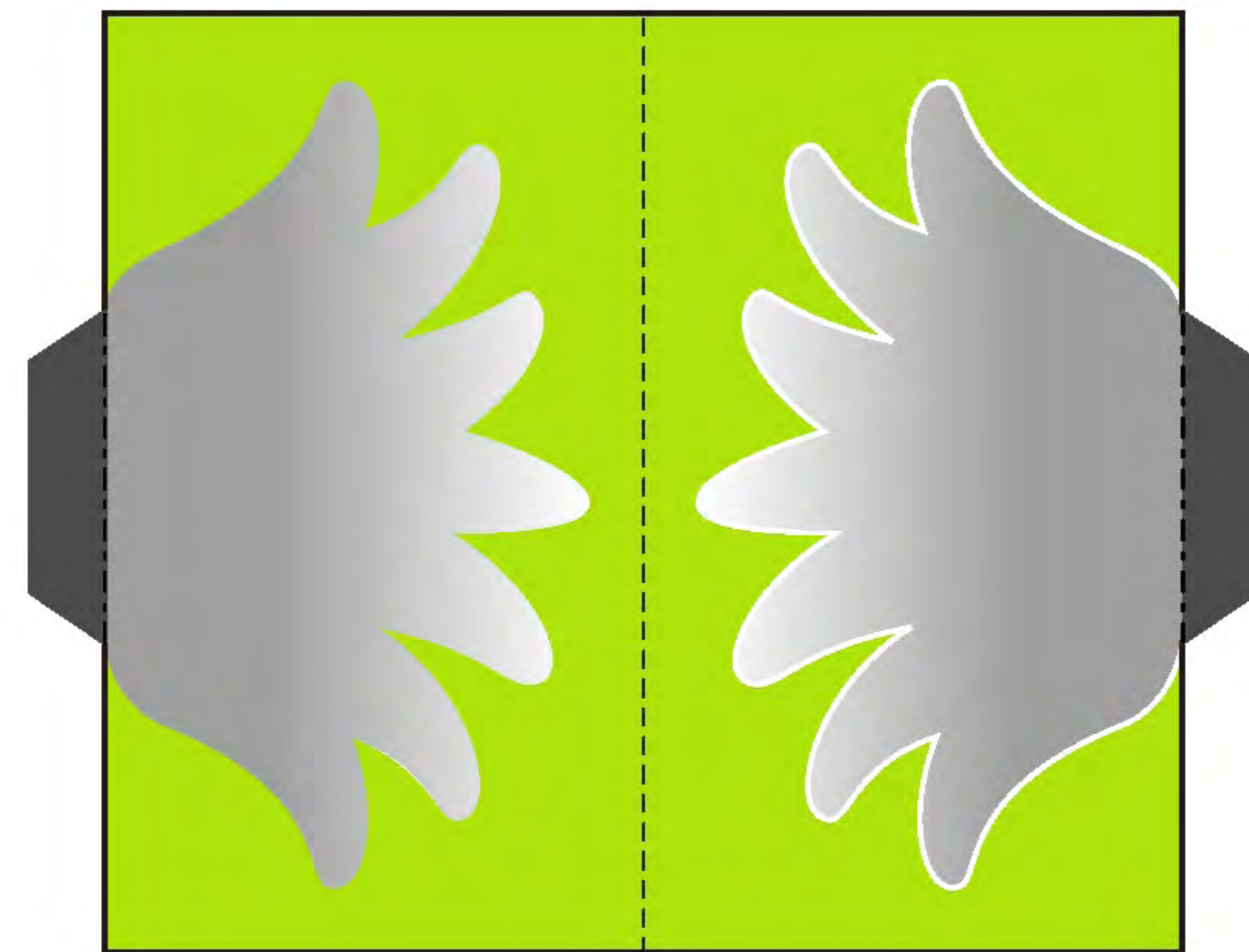

B 4

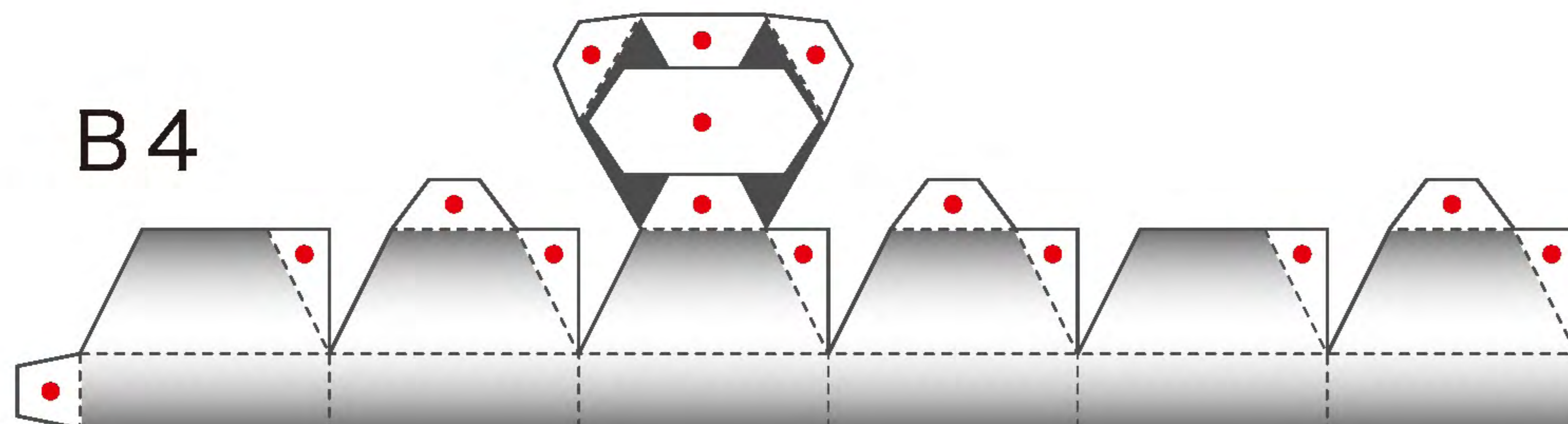

C 1

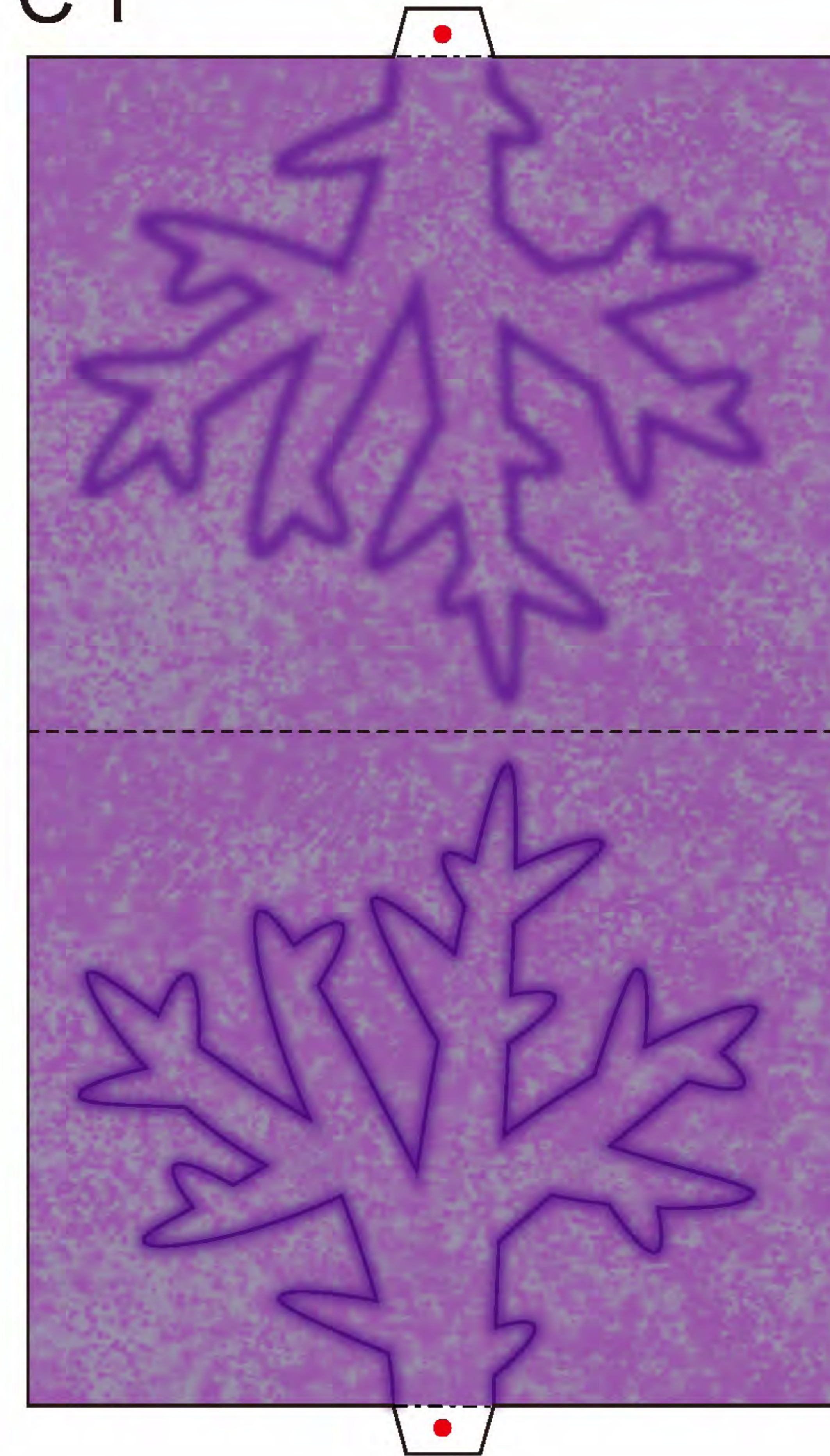

C 2

